

Product Parts Breakdown

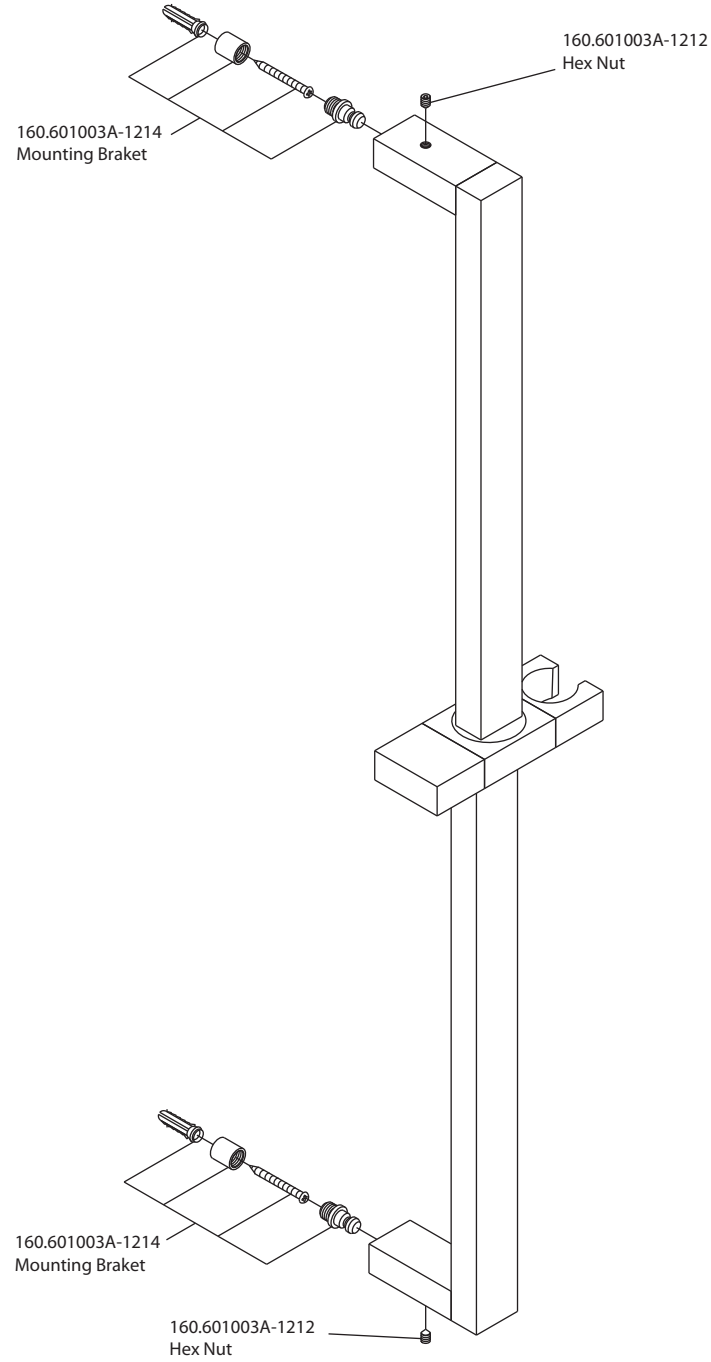

isenberg
innovation+design

160.601003A

Ver 2.53